

### GENERAL DESCRIPTION

The SGM2200 is a high voltage, high accuracy and low dropout voltage linear regulator. It is capable of supplying 50mA output current with typical dropout voltage of only 35mV. The operating input voltage is up to 26.4V. The output voltage range is from 1.5V to 5.0V in fixed output version. For adjustable output version, the output voltage can be adjusted from 1.5V to 5.0V by using external resistors.

Other features include current limit and thermal shutdown protection.

The SGM2200 is suitable for application which needs low dropout voltage and high voltage, such as palmtops high-power boost applications, etc. Fixed or adjustable output voltage versions are provided.

The SGM2200 is available in Green SOT-89-3, SOT-23, TSOT-23-5 and SC70-5 packages. It operates over an operating temperature range of -40°C to +85°C.

### FEATURES

- **High Input Voltage: Up to 26.4V**
- **Fixed Output Voltages: 1.5V, 1.8V, 2.5V, 2.8V, 3.0V, 3.3V, 3.6V, 4.4V and 5.0V**
- **Adjustable Output from 1.5V to 5.0V**
- **50mA Guaranteed Output Current**
- **Output Voltage Accuracy:  $\pm 3\%$  at +25°C**
- **Low Dropout Voltage: 35mV (TYP)**
- **Low Power Consumption: 1.7 $\mu$ A (TYP)**
- **Low Temperature Coefficient**
- **Thermal Shutdown Protection**
- **Output Current Limit**
- **-40°C to +85°C Operating Temperature Range**
- **Available in Green SOT-89-3, SOT-23, TSOT-23-5 and SC70-5 Packages**

### APPLICATIONS

Palmtops

High-Power Boost Applications

Power Source for Battery-Powered Equipment

Home Electric/Electronic Appliances

## PACKAGE/ORDERING INFORMATION

MODEL	PACKAGE DESCRIPTION	SPECIFIED TEMPERATURE RANGE	ORDERING NUMBER	PACKAGE MARKING	PACKING OPTION
SGM2200-1.5	SOT-89-3	-40°C to +85°C	SGM2200-1.5YK3G/TR	SCFXX	Tape and Reel, 1000
SGM2200-1.8	SOT-89-3	-40°C to +85°C	SGM2200-1.8YK3G/TR	SD0XX	Tape and Reel, 1000
SGM2200-2.5	SOT-89-3	-40°C to +85°C	SGM2200-2.5YK3G/TR	SD1XX	Tape and Reel, 1000
SGM2200-2.8	SOT-89-3	-40°C to +85°C	SGM2200-2.8YK3G/TR	SD2XX	Tape and Reel, 1000
SGM2200-3.0	SOT-89-3	-40°C to +85°C	SGM2200-3.0YK3G/TR	SD3XX	Tape and Reel, 1000
SGM2200-3.3	SOT-89-3	-40°C to +85°C	SGM2200-3.3YK3G/TR	SB7XX	Tape and Reel, 1000
SGM2200-3.6	SOT-89-3	-40°C to +85°C	SGM2200-3.6YK3G/TR	SD4XX	Tape and Reel, 1000
SGM2200-4.4	SOT-89-3	-40°C to +85°C	SGM2200-4.4YK3G/TR	SD5XX	Tape and Reel, 1000
SGM2200-5.0	SOT-89-3	-40°C to +85°C	SGM2200-5.0YK3G/TR	SD6XX	Tape and Reel, 1000
SGM2200-1.5	SOT-23	-40°C to +85°C	SGM2200-1.5YN3LG/TR	SD7XX	Tape and Reel, 3000
SGM2200-1.8	SOT-23	-40°C to +85°C	SGM2200-1.8YN3LG/TR	SD8XX	Tape and Reel, 3000
SGM2200-2.5	SOT-23	-40°C to +85°C	SGM2200-2.5YN3LG/TR	SD9XX	Tape and Reel, 3000
SGM2200-2.8	SOT-23	-40°C to +85°C	SGM2200-2.8YN3LG/TR	SDAXX	Tape and Reel, 3000
SGM2200-3.0	SOT-23	-40°C to +85°C	SGM2200-3.0YN3LG/TR	SDBXX	Tape and Reel, 3000
SGM2200-3.3	SOT-23	-40°C to +85°C	SGM2200-3.3YN3LG/TR	SCCXX	Tape and Reel, 3000
SGM2200-3.6	SOT-23	-40°C to +85°C	SGM2200-3.6YN3LG/TR	SDCXX	Tape and Reel, 3000
SGM2200-4.4	SOT-23	-40°C to +85°C	SGM2200-4.4YN3LG/TR	SDDXX	Tape and Reel, 3000
SGM2200-5.0	SOT-23	-40°C to +85°C	SGM2200-5.0YN3LG/TR	SCDXX	Tape and Reel, 3000

**PACKAGE/ORDERING INFORMATION (continued)**

MODEL	PACKAGE DESCRIPTION	SPECIFIED TEMPERATURE RANGE	ORDERING NUMBER	PACKAGE MARKING	PACKING OPTION
SGM2200-1.5	TSOT-23-5	-40°C to +85°C	SGM2200-1.5YTN5G/TR	SDEXX	Tape and Reel, 3000
SGM2200-1.8	TSOT-23-5	-40°C to +85°C	SGM2200-1.8YTN5G/TR	SDFXX	Tape and Reel, 3000
SGM2200-2.5	TSOT-23-5	-40°C to +85°C	SGM2200-2.5YTN5G/TR	SE0XX	Tape and Reel, 3000
SGM2200-2.8	TSOT-23-5	-40°C to +85°C	SGM2200-2.8YTN5G/TR	SE1XX	Tape and Reel, 3000
SGM2200-3.0	TSOT-23-5	-40°C to +85°C	SGM2200-3.0YTN5G/TR	SE2XX	Tape and Reel, 3000
SGM2200-3.3	TSOT-23-5	-40°C to +85°C	SGM2200-3.3YTN5G/TR	SE3XX	Tape and Reel, 3000
SGM2200-3.6	TSOT-23-5	-40°C to +85°C	SGM2200-3.6YTN5G/TR	SE4XX	Tape and Reel, 3000
SGM2200-4.4	TSOT-23-5	-40°C to +85°C	SGM2200-4.4YTN5G/TR	SE5XX	Tape and Reel, 3000
SGM2200-5.0	TSOT-23-5	-40°C to +85°C	SGM2200-5.0YTN5G/TR	SE6XX	Tape and Reel, 3000
SGM2200-ADJ	TSOT-23-5	-40°C to +85°C	SGM2200-ADJYTN5G/TR	SC3XX	Tape and Reel, 3000
SGM2200-1.5	SC70-5	-40°C to +85°C	SGM2200-1.5YC5G/TR	SE7XX	Tape and Reel, 3000
SGM2200-1.8	SC70-5	-40°C to +85°C	SGM2200-1.8YC5G/TR	SE8XX	Tape and Reel, 3000
SGM2200-2.5	SC70-5	-40°C to +85°C	SGM2200-2.5YC5G/TR	SE9XX	Tape and Reel, 3000
SGM2200-2.8	SC70-5	-40°C to +85°C	SGM2200-2.8YC5G/TR	SEAXX	Tape and Reel, 3000
SGM2200-3.0	SC70-5	-40°C to +85°C	SGM2200-3.0YC5G/TR	SEBXX	Tape and Reel, 3000
SGM2200-3.3	SC70-5	-40°C to +85°C	SGM2200-3.3YC5G/TR	SECXX	Tape and Reel, 3000
SGM2200-3.6	SC70-5	-40°C to +85°C	SGM2200-3.6YC5G/TR	SEDXX	Tape and Reel, 3000
SGM2200-4.4	SC70-5	-40°C to +85°C	SGM2200-4.4YC5G/TR	SEEXX	Tape and Reel, 3000
SGM2200-5.0	SC70-5	-40°C to +85°C	SGM2200-5.0YC5G/TR	SEFXX	Tape and Reel, 3000
SGM2200-ADJ	SC70-5	-40°C to +85°C	SGM2200-ADJYC5G/TR	SF0XX	Tape and Reel, 3000

**MARKING INFORMATION**

NOTE: XX = Date Code.

**YYY X X**

Date Code - Month

Date Code - Year

Serial Number

Green (RoHS & HSF): SG Micro Corp defines "Green" to mean Pb-Free (RoHS compatible) and free of halogen substances. If you have additional comments or questions, please contact your SGMICRO representative directly.

**ABSOLUTE MAXIMUM RATINGS**

Supply Voltage.....	-0.3V to 32V
VOUT, FB to GND .....	-0.3V to Min(V <sub>IN</sub> + 0.3V, 6V)
Power Dissipation, P <sub>D</sub> @ T <sub>A</sub> = +25°C	
SOT-89-3 .....	0.5W
TSOT-23-5.....	0.43W
SC70-5.....	0.3W
SOT-23 .....	0.28W
Package Thermal Resistance	
SOT-89-3, θ <sub>JA</sub> .....	200°C/W
TSOT-23-5, θ <sub>JA</sub> .....	250°C/W
SC70-5, θ <sub>JA</sub> .....	330°C/W
SOT-23, θ <sub>JA</sub> .....	360°C/W
Junction Temperature.....	+150°C
Storage Temperature Range .....	-65°C to +150°C
Lead Temperature (Soldering, 10s).....	+260°C
ESD Susceptibility (Fixed Voltage Version)	
HBM.....	3000V
MM.....	250V
ESD Susceptibility (Adjustable Voltage Version)	
HBM.....	2000V
MM.....	200V

**RECOMMENDED OPERATING CONDITIONS**

Operating Temperature Range .....	-40°C to +85°C
-----------------------------------	----------------

**OVERSTRESS CAUTION**

Stresses beyond those listed in Absolute Maximum Ratings may cause permanent damage to the device. Exposure to absolute maximum rating conditions for extended periods may affect reliability. Functional operation of the device at any conditions beyond those indicated in the Recommended Operating Conditions section is not implied.

**ESD SENSITIVITY CAUTION**

This integrated circuit can be damaged if ESD protections are not considered carefully. SGMICRO recommends that all integrated circuits be handled with appropriate precautions. Failure to observe proper handling and installation procedures can cause damage. ESD damage can range from subtle performance degradation to complete device failure. Precision integrated circuits may be more susceptible to damage because even small parametric changes could cause the device not to meet the published specifications.

**DISCLAIMER**

SG Micro Corp reserves the right to make any change in circuit design, or specifications without prior notice.

PIN CONFIGURATIONS

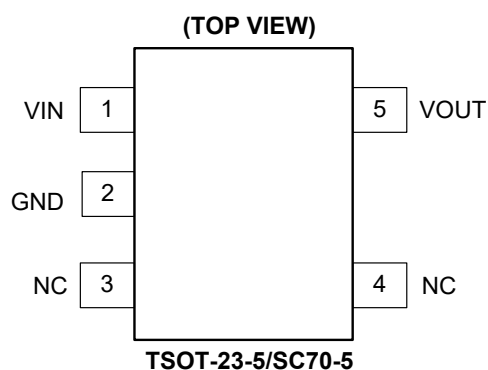
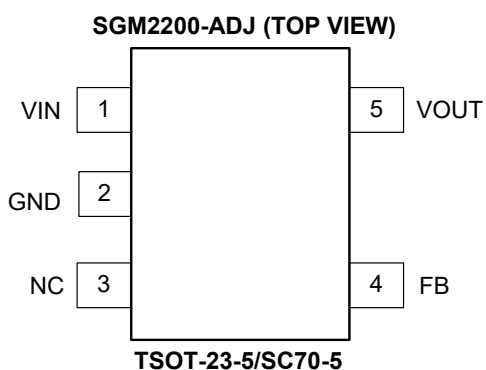
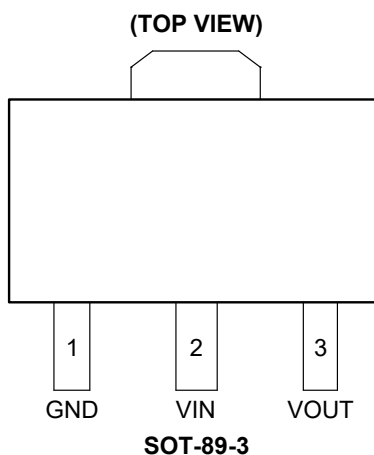
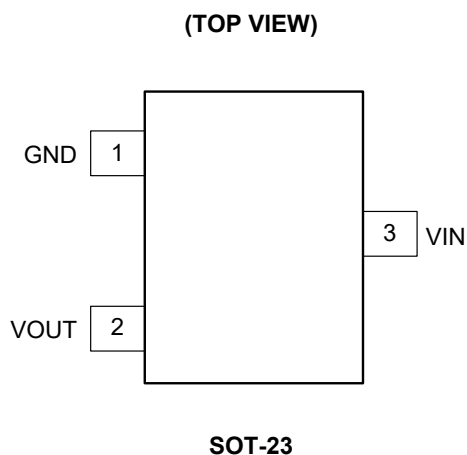

PIN DESCRIPTION

PIN			NAME	FUNCTION
TSOT-23-5/ SC70-5	SOT-23	SOT-89-3		
1	3	2	VIN	Regulator Input. Up to 26.4V operation voltage. It is recommended to use a 1μF or larger ceramic capacitor from VIN pin to ground.
2	1	1	GND	Ground.
3	–	–	NC	No Internal Connection.
4	–	–	FB	Feedback Voltage Input Pin. Connect this pin to the external resistor divider to adjust the output voltage.
			NC	No Internal Connection. (Fixed voltage version only).
5	2	3	VOUT	Regulator Output Pin. It is recommended to use an output capacitor with effective capacitance in the range of 1μF to 10μF. The capacitor should be located very close to this pin.

**ELECTRICAL CHARACTERISTICS**SGM2200-1.5,  $V_{IN} = 4V$ ,  $T_A = +25^\circ C$ , unless otherwise noted.

PARAMETER	SYMBOL	CONDITIONS	MIN	TYP	MAX	UNITS
Output Voltage	$V_{OUT}$	$I_{OUT} = 10mA$	1.455	1.500	1.545	V
Output Current	$I_{OUT}$		30	50		mA
Current Limit	$I_{LIM}$		55			mA
Line Regulation	$\frac{\Delta V_{OUT}}{\Delta V_{IN} \times V_{OUT}}$	$V_{IN} = 3V \text{ to } 26.4V, I_{OUT} = 1mA$		0.01		%/V
Load Regulation	$\Delta V_{OUT}$	$I_{OUT} = 1mA \text{ to } 30mA$			10	mV
Current Consumption	$I_Q$	No Load		1.7	3.6	$\mu A$
Thermal Shutdown Temperature	$T_{SHDN}$			130		$^\circ C$
Thermal Shutdown Hysteresis	$\Delta T_{SHDN}$			15		$^\circ C$
Temperature Coefficient	$\frac{\Delta V_{OUT}}{\Delta T_A \times V_{OUT}}$	$I_{OUT} = 10mA, T_A = -40^\circ C \text{ to } +85^\circ C$		$\pm 60$		ppm/ $^\circ C$

SGM2200-1.8,  $V_{IN} = 4V$ ,  $T_A = +25^\circ C$ , unless otherwise noted.

PARAMETER	SYMBOL	CONDITIONS	MIN	TYP	MAX	UNITS
Output Voltage	$V_{OUT}$	$I_{OUT} = 10mA$	1.746	1.800	1.854	V
Output Current	$I_{OUT}$		30	50		mA
Current Limit	$I_{LIM}$		55			mA
Line Regulation	$\frac{\Delta V_{OUT}}{\Delta V_{IN} \times V_{OUT}}$	$V_{IN} = 3V \text{ to } 26.4V, I_{OUT} = 1mA$		0.01		%/V
Load Regulation	$\Delta V_{OUT}$	$I_{OUT} = 1mA \text{ to } 30mA$			10	mV
Current Consumption	$I_Q$	No Load		1.7	3.6	$\mu A$
Thermal Shutdown Temperature	$T_{SHDN}$			130		$^\circ C$
Thermal Shutdown Hysteresis	$\Delta T_{SHDN}$			15		$^\circ C$
Temperature Coefficient	$\frac{\Delta V_{OUT}}{\Delta T_A \times V_{OUT}}$	$I_{OUT} = 10mA, T_A = -40^\circ C \text{ to } +85^\circ C$		$\pm 60$		ppm/ $^\circ C$

SGM2200-2.5,  $V_{IN} = 4.5V$ ,  $T_A = +25^\circ C$ , unless otherwise noted.

PARAMETER	SYMBOL	CONDITIONS	MIN	TYP	MAX	UNITS
Output Voltage	$V_{OUT}$	$I_{OUT} = 10mA$	2.425	2.500	2.575	V
Output Current	$I_{OUT}$		30	50		mA
Current Limit	$I_{LIM}$		55			mA
Line Regulation	$\frac{\Delta V_{OUT}}{\Delta V_{IN} \times V_{OUT}}$	$V_{IN} = 3.5V \text{ to } 26.4V, I_{OUT} = 1mA$		0.01		%/V
Load Regulation	$\Delta V_{OUT}$	$I_{OUT} = 1mA \text{ to } 30mA$			10	mV
Dropout Voltage		$I_{OUT} = 1mA$		35		mV
Current Consumption	$I_Q$	No Load		1.75	3.8	$\mu A$
Thermal Shutdown Temperature	$T_{SHDN}$			130		$^\circ C$
Thermal Shutdown Hysteresis	$\Delta T_{SHDN}$			15		$^\circ C$
Temperature Coefficient	$\frac{\Delta V_{OUT}}{\Delta T_A \times V_{OUT}}$	$I_{OUT} = 10mA, T_A = -40^\circ C \text{ to } +85^\circ C$		$\pm 60$		ppm/ $^\circ C$

**ELECTRICAL CHARACTERISTICS (continued)**SGM2200-2.8,  $V_{IN} = 4.8V$ ,  $T_A = +25^\circ C$ , unless otherwise noted.

PARAMETER	SYMBOL	CONDITIONS	MIN	TYP	MAX	UNITS
Output Voltage	$V_{OUT}$	$I_{OUT} = 10mA$	2.716	2.800	2.884	V
Output Current	$I_{OUT}$		30	50		mA
Current Limit	$I_{LIM}$		55			mA
Line Regulation	$\frac{\Delta V_{OUT}}{\Delta V_{IN} \times V_{OUT}}$	$V_{IN} = 3.8V \text{ to } 26.4V$ , $I_{OUT} = 1mA$		0.01		%/V
Load Regulation	$\Delta V_{OUT}$	$I_{OUT} = 1mA \text{ to } 30mA$			10	mV
Dropout Voltage		$I_{OUT} = 1mA$		35		mV
Current Consumption	$I_Q$	No Load		1.75	3.8	$\mu A$
Thermal Shutdown Temperature	$T_{SHDN}$			130		$^\circ C$
Thermal Shutdown Hysteresis	$\Delta T_{SHDN}$			15		$^\circ C$
Temperature Coefficient	$\frac{\Delta V_{OUT}}{\Delta T_A \times V_{OUT}}$	$I_{OUT} = 10mA$ , $T_A = -40^\circ C \text{ to } +85^\circ C$		$\pm 60$		ppm/ $^\circ C$

SGM2200-3.0,  $V_{IN} = 5.0V$ ,  $T_A = +25^\circ C$ , unless otherwise noted.

PARAMETER	SYMBOL	CONDITIONS	MIN	TYP	MAX	UNITS
Output Voltage	$V_{OUT}$	$I_{OUT} = 10mA$	2.91	3.00	3.09	V
Output Current	$I_{OUT}$		30	50		mA
Current Limit	$I_{LIM}$		55			mA
Line Regulation	$\frac{\Delta V_{OUT}}{\Delta V_{IN} \times V_{OUT}}$	$V_{IN} = 4V \text{ to } 26.4V$ , $I_{OUT} = 1mA$		0.01		%/V
Load Regulation	$\Delta V_{OUT}$	$I_{OUT} = 1mA \text{ to } 30mA$			10	mV
Dropout Voltage		$I_{OUT} = 1mA$		35		mV
Current Consumption	$I_Q$	No Load		1.75	3.8	$\mu A$
Thermal Shutdown Temperature	$T_{SHDN}$			130		$^\circ C$
Thermal Shutdown Hysteresis	$\Delta T_{SHDN}$			15		$^\circ C$
Temperature Coefficient	$\frac{\Delta V_{OUT}}{\Delta T_A \times V_{OUT}}$	$I_{OUT} = 10mA$ , $T_A = -40^\circ C \text{ to } +85^\circ C$		$\pm 60$		ppm/ $^\circ C$

SGM2200-3.3,  $V_{IN} = 5.5V$ ,  $T_A = +25^\circ C$ , unless otherwise noted.

PARAMETER	SYMBOL	CONDITIONS	MIN	TYP	MAX	UNITS
Output Voltage	$V_{OUT}$	$I_{OUT} = 10mA$	3.201	3.300	3.399	V
Output Current	$I_{OUT}$		30	50		mA
Current Limit	$I_{LIM}$		55			mA
Line Regulation	$\frac{\Delta V_{OUT}}{\Delta V_{IN} \times V_{OUT}}$	$V_{IN} = 4.5V \text{ to } 26.4V$ , $I_{OUT} = 1mA$		0.01		%/V
Load Regulation	$\Delta V_{OUT}$	$I_{OUT} = 1mA \text{ to } 30mA$			10	mV
Dropout Voltage		$I_{OUT} = 1mA$		35		mV
Current Consumption	$I_Q$	No Load		1.75	3.8	$\mu A$
Thermal Shutdown Temperature	$T_{SHDN}$			130		$^\circ C$
Thermal Shutdown Hysteresis	$\Delta T_{SHDN}$			15		$^\circ C$
Temperature Coefficient	$\frac{\Delta V_{OUT}}{\Delta T_A \times V_{OUT}}$	$I_{OUT} = 10mA$ , $T_A = -40^\circ C \text{ to } +85^\circ C$		$\pm 60$		ppm/ $^\circ C$

**ELECTRICAL CHARACTERISTICS (continued)**SGM2200-3.6,  $V_{IN} = 5.6V$ ,  $T_A = +25^\circ C$ , unless otherwise noted.

PARAMETER	SYMBOL	CONDITIONS	MIN	TYP	MAX	UNITS
Output Voltage	$V_{OUT}$	$I_{OUT} = 10mA$	3.492	3.600	3.708	V
Output Current	$I_{OUT}$		30	50		mA
Current Limit	$I_{LIM}$		55			mA
Line Regulation	$\frac{\Delta V_{OUT}}{\Delta V_{IN} \times V_{OUT}}$	$V_{IN} = 4.6V \text{ to } 26.4V, I_{OUT} = 1mA$		0.01		%/V
Load Regulation	$\Delta V_{OUT}$	$I_{OUT} = 1mA \text{ to } 30mA$			10	mV
Dropout Voltage		$I_{OUT} = 1mA$		35		mV
Current Consumption	$I_Q$	No Load		1.75	3.8	$\mu A$
Thermal Shutdown Temperature	$T_{SHDN}$			130		$^\circ C$
Thermal Shutdown Hysteresis	$\Delta T_{SHDN}$			15		$^\circ C$
Temperature Coefficient	$\frac{\Delta V_{OUT}}{\Delta T_A \times V_{OUT}}$	$I_{OUT} = 10mA, T_A = -40^\circ C \text{ to } +85^\circ C$		$\pm 60$		ppm/ $^\circ C$

SGM2200-4.4,  $V_{IN} = 6.4V$ ,  $T_A = +25^\circ C$ , unless otherwise noted.

PARAMETER	SYMBOL	CONDITIONS	MIN	TYP	MAX	UNITS
Output Voltage	$V_{OUT}$	$I_{OUT} = 10mA$	4.268	4.400	4.532	V
Output Current	$I_{OUT}$		30	50		mA
Current Limit	$I_{LIM}$		55			mA
Line Regulation	$\frac{\Delta V_{OUT}}{\Delta V_{IN} \times V_{OUT}}$	$V_{IN} = 5.4V \text{ to } 26.4V, I_{OUT} = 1mA$		0.01		%/V
Load Regulation	$\Delta V_{OUT}$	$I_{OUT} = 1mA \text{ to } 30mA$			10	mV
Dropout Voltage		$I_{OUT} = 1mA$		35		mV
Current Consumption	$I_Q$	No Load		1.75	3.8	$\mu A$
Thermal Shutdown Temperature	$T_{SHDN}$			130		$^\circ C$
Thermal Shutdown Hysteresis	$\Delta T_{SHDN}$			15		$^\circ C$
Temperature Coefficient	$\frac{\Delta V_{OUT}}{\Delta T_A \times V_{OUT}}$	$I_{OUT} = 10mA, T_A = -40^\circ C \text{ to } +85^\circ C$		$\pm 60$		ppm/ $^\circ C$

SGM2200-5.0,  $V_{IN} = 7V$ ,  $T_A = +25^\circ C$ , unless otherwise noted.

PARAMETER	SYMBOL	CONDITIONS	MIN	TYP	MAX	UNITS
Output Voltage	$V_{OUT}$	$I_{OUT} = 10mA$	4.85	5.00	5.15	V
Output Current	$I_{OUT}$		30	50		mA
Current Limit	$I_{LIM}$		55			mA
Line Regulation	$\frac{\Delta V_{OUT}}{\Delta V_{IN} \times V_{OUT}}$	$V_{IN} = 6V \text{ to } 26.4V, I_{OUT} = 1mA$		0.01		%/V
Load Regulation	$\Delta V_{OUT}$	$I_{OUT} = 1mA \text{ to } 30mA$			10	mV
Dropout Voltage		$I_{OUT} = 1mA$		35		mV
Current Consumption	$I_Q$	No Load		1.75	3.8	$\mu A$
Thermal Shutdown Temperature	$T_{SHDN}$			130		$^\circ C$
Thermal Shutdown Hysteresis	$\Delta T_{SHDN}$			15		$^\circ C$
Temperature Coefficient	$\frac{\Delta V_{OUT}}{\Delta T_A \times V_{OUT}}$	$I_{OUT} = 10mA, T_A = -40^\circ C \text{ to } +85^\circ C$		$\pm 60$		ppm/ $^\circ C$



**ELECTRICAL CHARACTERISTICS (continued)**SGM2200-ADJ,  $V_{IN} = V_{OUT(NOMINAL)} + 2V$  or  $4V$  (whichever is greater),  $T_A = +25^{\circ}C$ , unless otherwise noted.

PARAMETER	SYMBOL	CONDITIONS	MIN	TYP	MAX	UNITS
Adjustable Output Voltage Range	$V_{OUT}$		1.5		5.0	V
Output Voltage Accuracy <sup>(1)</sup>		$I_{OUT} = 10mA$	-3		+3	%
Output Current	$I_{OUT}$		30	50		mA
Current Limit	$I_{LIM}$		55			mA
Line Regulation	$\frac{\Delta V_{OUT}}{\Delta V_{IN} \times V_{OUT}}$	$V_{IN} = 4.6V$ to $26.4V$ , $I_{OUT} = 1mA$ , $V_{OUT} = 3.6V$		0.01		%/V
Load Regulation	$\Delta V_{OUT}$	$I_{OUT} = 1mA$ to $30mA$ , $V_{OUT} = 3.6V$			10	mV
Dropout Voltage		$I_{OUT} = 1mA$ , $V_{OUT} = 3.6V$		35		mV
Current Consumption	$I_Q$	Ground Current		1.45	3.5	$\mu A$
Feedback Voltage	$V_{FB}$			1.221		V
Thermal Shutdown Temperature	$T_{SHDN}$			130		$^{\circ}C$
Thermal Shutdown Hysteresis	$\Delta T_{SHDN}$			15		$^{\circ}C$
Temperature Coefficient	$\frac{\Delta V_{OUT}}{\Delta T_A \times V_{OUT}}$	$I_{OUT} = 10mA$ , $T_A = -40^{\circ}C$ to $+85^{\circ}C$		$\pm 60$		ppm/ $^{\circ}C$

## NOTE:

1. The accuracy of the feedback resistors used in Figure 2, has a direct impact on the output voltage accuracy.

TYPICAL PERFORMANCE CHARACTERISTICS

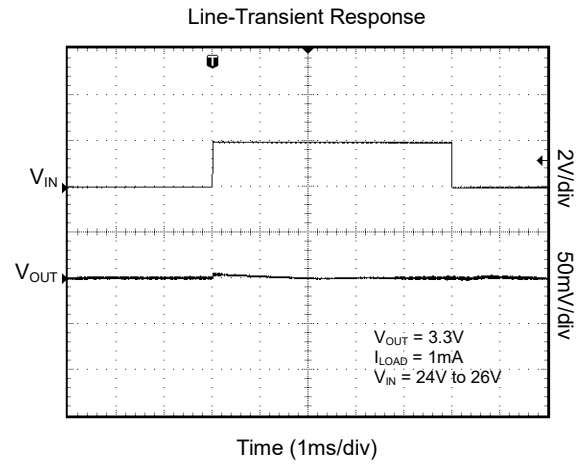
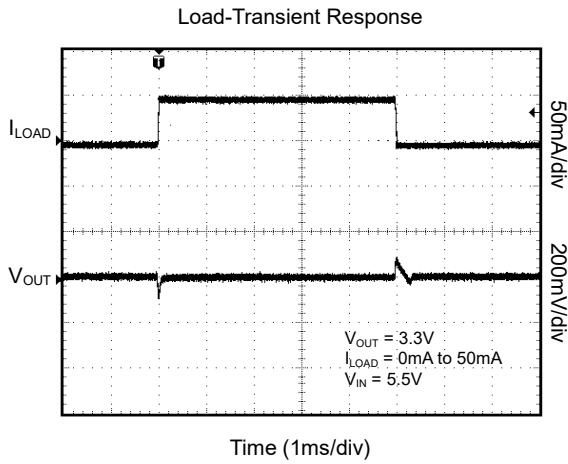
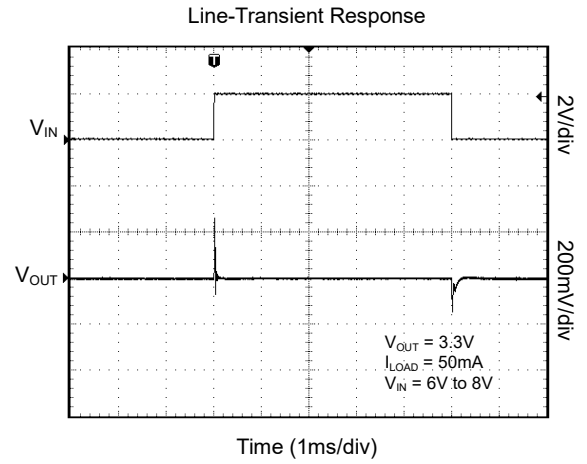
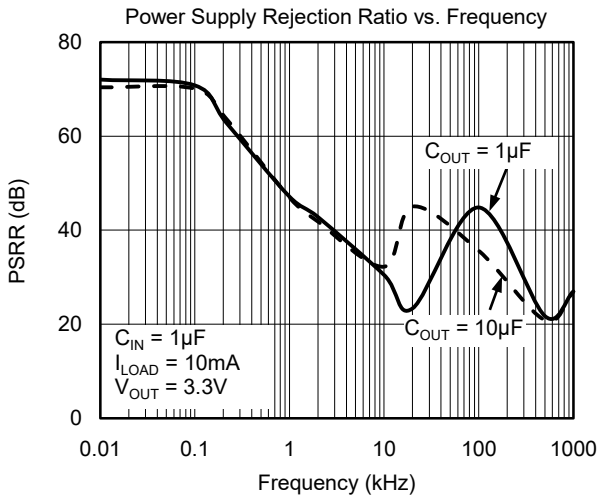

TYPICAL APPLICATION CIRCUITS

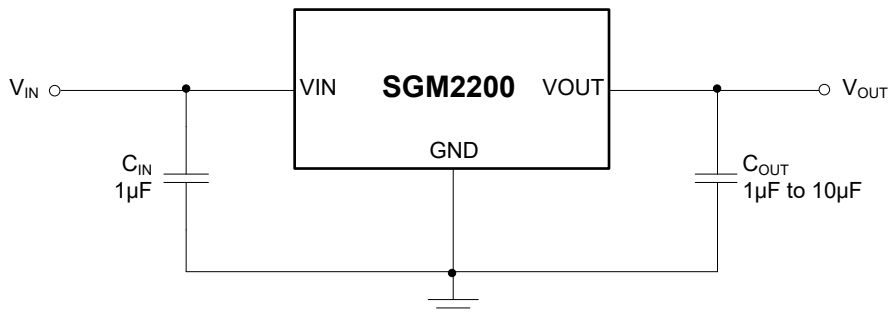

Figure 1. Fixed Voltage Typical Application Circuit

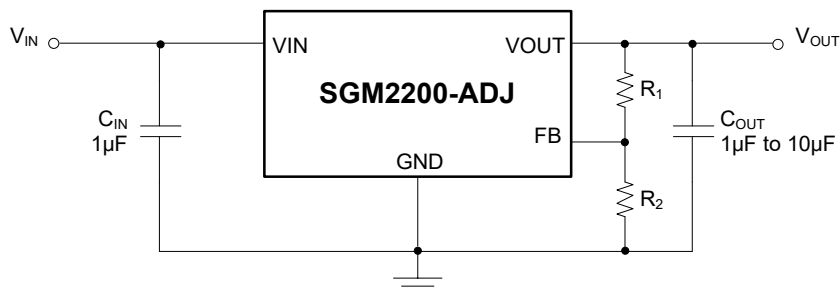

Figure 2. Adjustable Voltage Typical Application Circuit

Standard 1% Resistor Values for Common Output Voltages of Adjustable Voltage Version

V <sub>OUT</sub> (V)	R <sub>1</sub> (kΩ)	R <sub>2</sub> (kΩ)
1.5	120	523
1.8	280	590
2.5	680	649
3.3	953	560
3.6	1000	511
4.4	1500	576
5.0	2000	649

NOTE:  $V_{OUT} = (R_1 + R_2)/R_2 \times 1.221$

## REVISION HISTORY

NOTE: Page numbers for previous revisions may differ from page numbers in the current version.

<b>AUGUST 2019 – REV.A.2 to REV.A.3</b> .....	<b>Page</b>
Updated Electrical Characteristics section .....	6-9
<b>JANUARY 2013 – REV.A.1 to REV.A.2</b> .....	<b>Page</b>
Added Temperature Coefficient.....	6-9
<b>DECEMBER 2012 – REV.A to REV.A.1</b> .....	<b>Page</b>
Changed Feedback Voltage.....	9
Added the Table of Resistor Values for Common Output Voltages of Adjustable Voltage Version.....	10
<b>Changes from Original (OCTOBER 2012) to REV.A</b> .....	<b>Page</b>
Changed from product preview to production data.....	All

PACKAGE OUTLINE DIMENSIONS

SOT-89-3

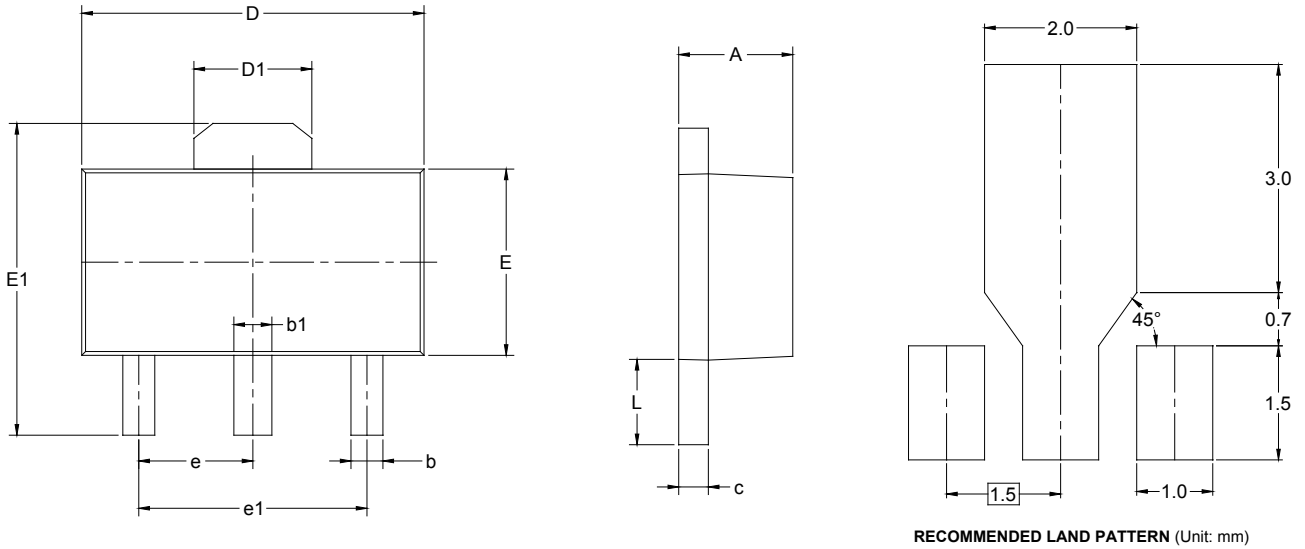

Symbol	Dimensions In Millimeters		Dimensions In Inches	
	MIN	MAX	MIN	MAX
A	1.400	1.600	0.055	0.063
b	0.320	0.520	0.013	0.020
b1	0.400	0.580	0.016	0.023
c	0.350	0.440	0.014	0.017
D	4.400	4.600	0.173	0.181
D1	1.550 REF		0.061 REF	
E	2.300	2.600	0.091	0.102
E1	3.940	4.250	0.155	0.167
e	1.500 TYP		0.060 TYP	
e1	3.000 TYP		0.118 TYP	
L	0.900	1.200	0.035	0.047

PACKAGE OUTLINE DIMENSIONS

SOT-23

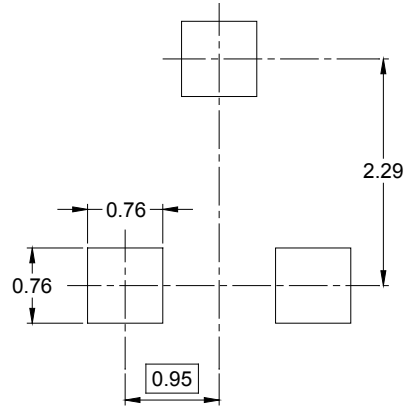
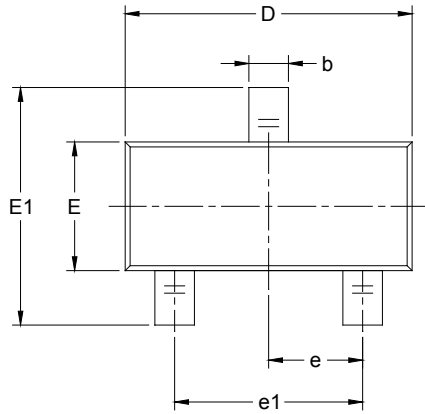

RECOMMENDED LAND PATTERN (Unit: mm)

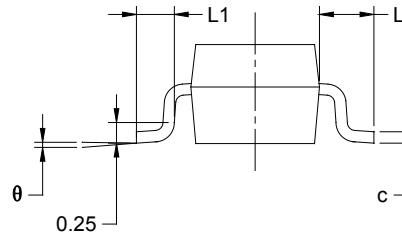
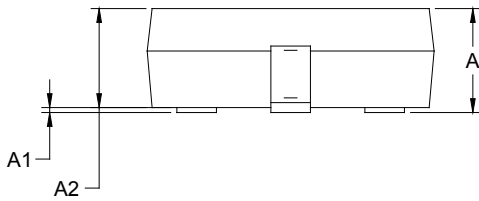

Symbol	Dimensions In Millimeters		Dimensions In Inches	
	MIN	MAX	MIN	MAX
A	0.900	1.150	0.035	0.045
A1	0.000	0.100	0.000	0.004
A2	0.900	1.050	0.035	0.041
b	0.300	0.500	0.012	0.020
c	0.080	0.150	0.003	0.006
D	2.800	3.000	0.110	0.118
E	1.200	1.400	0.047	0.055
E1	2.250	2.550	0.089	0.100
e	0.950 BSC		0.037 BSC	
e1	1.900 BSC		0.075 BSC	
L	0.550 REF		0.022 REF	
L1	0.300	0.500	0.012	0.020
$\theta$	0°	8°	0°	8°

PACKAGE OUTLINE DIMENSIONS

TSOT-23-5

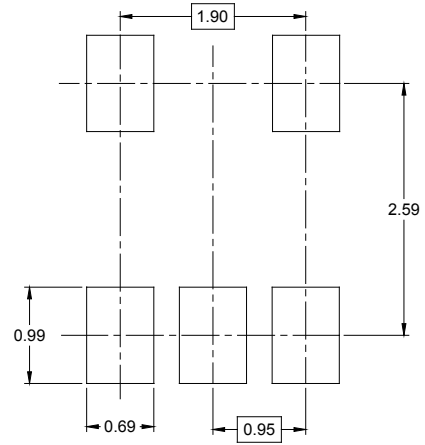
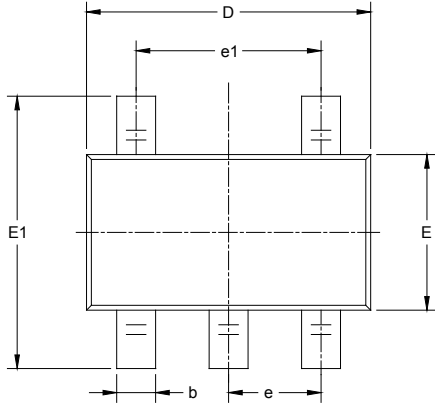

RECOMMENDED LAND PATTERN (Unit: mm)

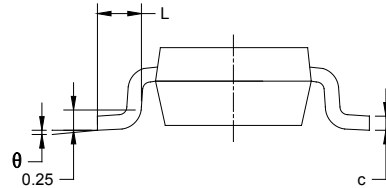
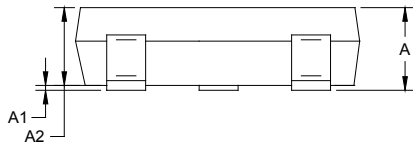

Symbol	Dimensions In Millimeters		Dimensions In Inches	
	MIN	MAX	MIN	MAX
A	0.700	0.900	0.028	0.035
A1	0.000	0.100	0.000	0.004
A2	0.700	0.800	0.028	0.031
b	0.350	0.500	0.014	0.020
c	0.080	0.200	0.003	0.008
D	2.820	3.020	0.111	0.119
E	1.600	1.700	0.063	0.067
E1	2.650	2.950	0.104	0.116
e	0.950 BSC		0.037 BSC	
e1	1.900 BSC		0.075 BSC	
L	0.300	0.600	0.012	0.024
$\theta$	0°	8°	0°	8°

PACKAGE OUTLINE DIMENSIONS

SC70-5

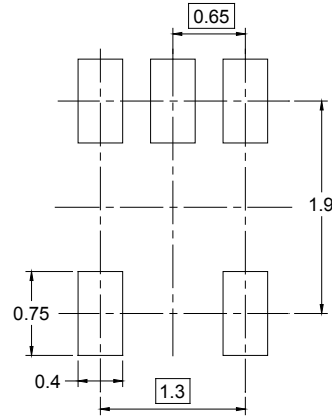
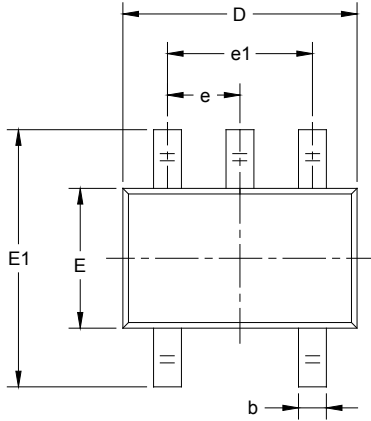

RECOMMENDED LAND PATTERN (Unit: mm)

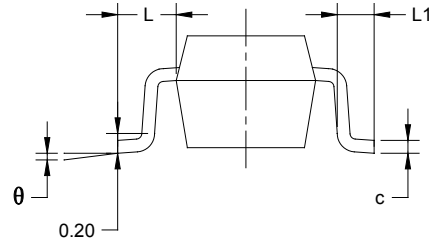
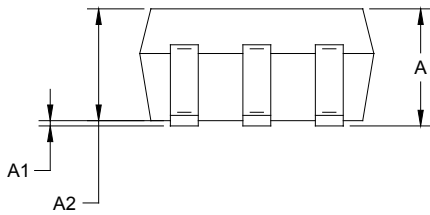

Symbol	Dimensions In Millimeters		Dimensions In Inches	
	MIN	MAX	MIN	MAX
A	0.900	1.100	0.035	0.043
A1	0.000	0.100	0.000	0.004
A2	0.900	1.000	0.035	0.039
b	0.150	0.350	0.006	0.014
c	0.080	0.150	0.003	0.006
D	2.000	2.200	0.079	0.087
E	1.150	1.350	0.045	0.053
E1	2.150	2.450	0.085	0.096
e	0.65 TYP		0.026 TYP	
e1	1.300 BSC		0.051 BSC	
L	0.525 REF		0.021 REF	
L1	0.260	0.460	0.010	0.018
$\theta$	0°	8°	0°	8°



# PACKAGE INFORMATION

## TAPE AND REEL INFORMATION

### REEL DIMENSIONS

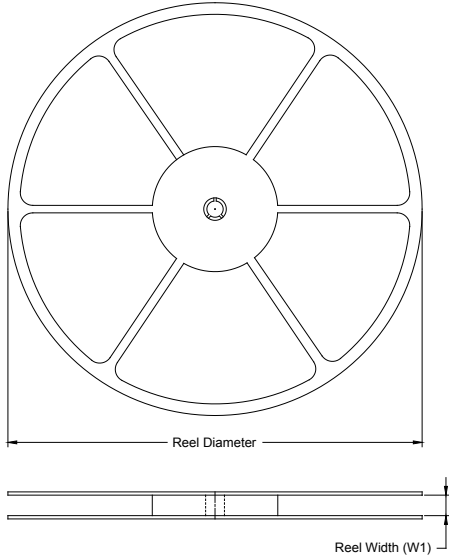

### TAPE DIMENSIONS

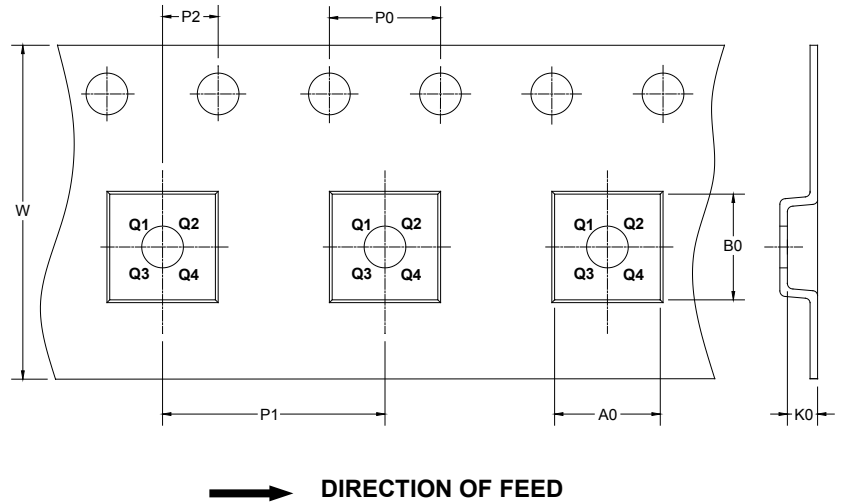

NOTE: The picture is only for reference. Please make the object as the standard.

### KEY PARAMETER LIST OF TAPE AND REEL

Package Type	Reel Diameter	Reel Width W1 (mm)	A0 (mm)	B0 (mm)	K0 (mm)	P0 (mm)	P1 (mm)	P2 (mm)	W (mm)	Pin1 Quadrant
SOT-89-3	7"	13.2	4.85	4.45	1.85	4.0	8.0	2.0	12.0	Q3
SOT-23	7"	9.5	3.15	2.77	1.22	4.0	4.0	2.0	8.0	Q3
TSOT-23-5	7"	9.5	3.17	3.10	1.10	4.0	4.0	2.0	8.0	Q3
SC70-5	7"	9.5	2.25	2.55	1.20	4.0	4.0	2.0	8.0	Q3

D00001

# PACKAGE INFORMATION

## CARTON BOX DIMENSIONS



NOTE: The picture is only for reference. Please make the object as the standard.

## KEY PARAMETER LIST OF CARTON BOX

Reel Type	Length (mm)	Width (mm)	Height (mm)	Pizza/Carton
7" (Option)	368	227	224	8
7"	442	410	224	18

DD0002